

FEATURES

NEXUS NSC 20 profile is a Stainless Steel Channel for profile Floors and Walls in both SS304 and SS316L Grades in Polished and Brush finish.

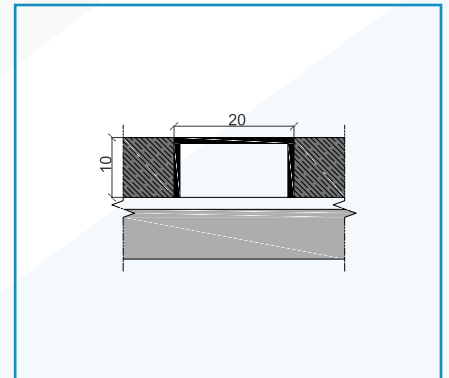
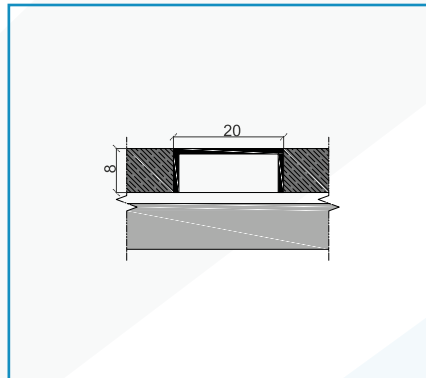
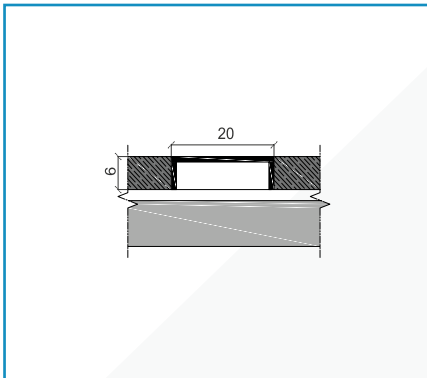

SS 304 Polish Finish

Type	H (mm)	W (mm)	L (m)
NSC 2006	6	20	2.7
NSC 2008	8	20	2.7
NSC 2010	10	20	2.7

SS 316 Polish Finish

Type	H (mm)	W (mm)	L (m)
NSCL 2006	6	20	2.7
NSCL 2008	8	20	2.7
NSCL 2010	10	20	2.7

SS 304 Brush Finish

Type	H (mm)	W (mm)	L (m)
NSCB 2006	6	20	2.7
NSCB 2008	8	20	2.7
NSCB 2010	10	20	2.7

SS 316 Brush Finish

Type	H (mm)	W (mm)	L (m)
NSCLB 2006	6	20	2.7
NSCLB 2008	8	20	2.7
NSCLB 2010	10	20	2.7