

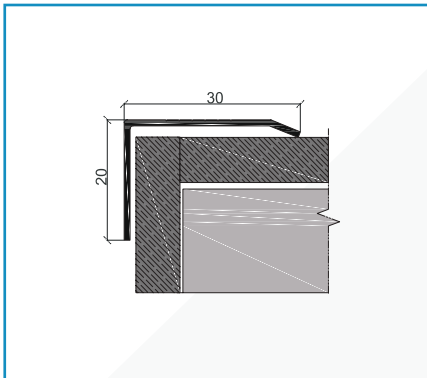

FEATURES

NEXUS SAST 3020 profile is a Stainless Steel Step Nosing in both SS304 and SS316L Grades in Polished and Brush finish.



SS 304 Polish Finish

Type	H (mm)	W (mm)	L (m)
SAST 3020	20	30	2.7

SS 316 Polish Finish

Type	H (mm)	W (mm)	L (m)
SASTL 3020	20	30	2.7

SS 304 Brush Finish

Type	H (mm)	W (mm)	L (m)
SASTB 3020	20	30	2.7

SS 316 Brush Finish

Type	H (mm)	W (mm)	L (m)
SASTLB 3020	20	30	2.7